

歩車道境界ブロック (群馬県型管渠型側溝用)

S-1:15

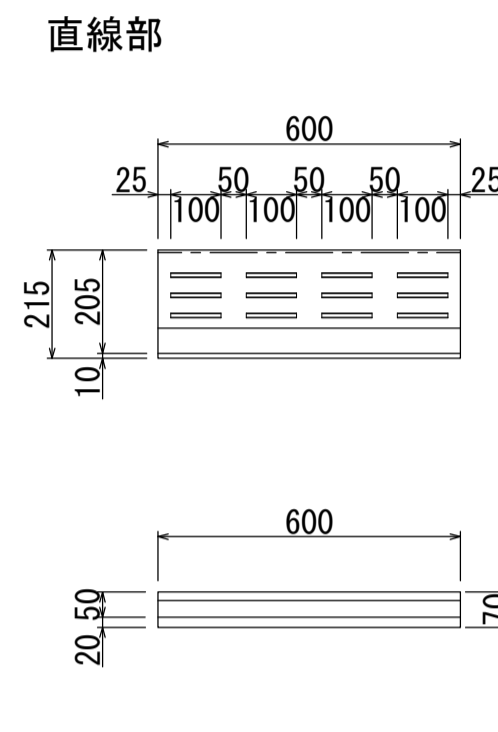

横断歩道部

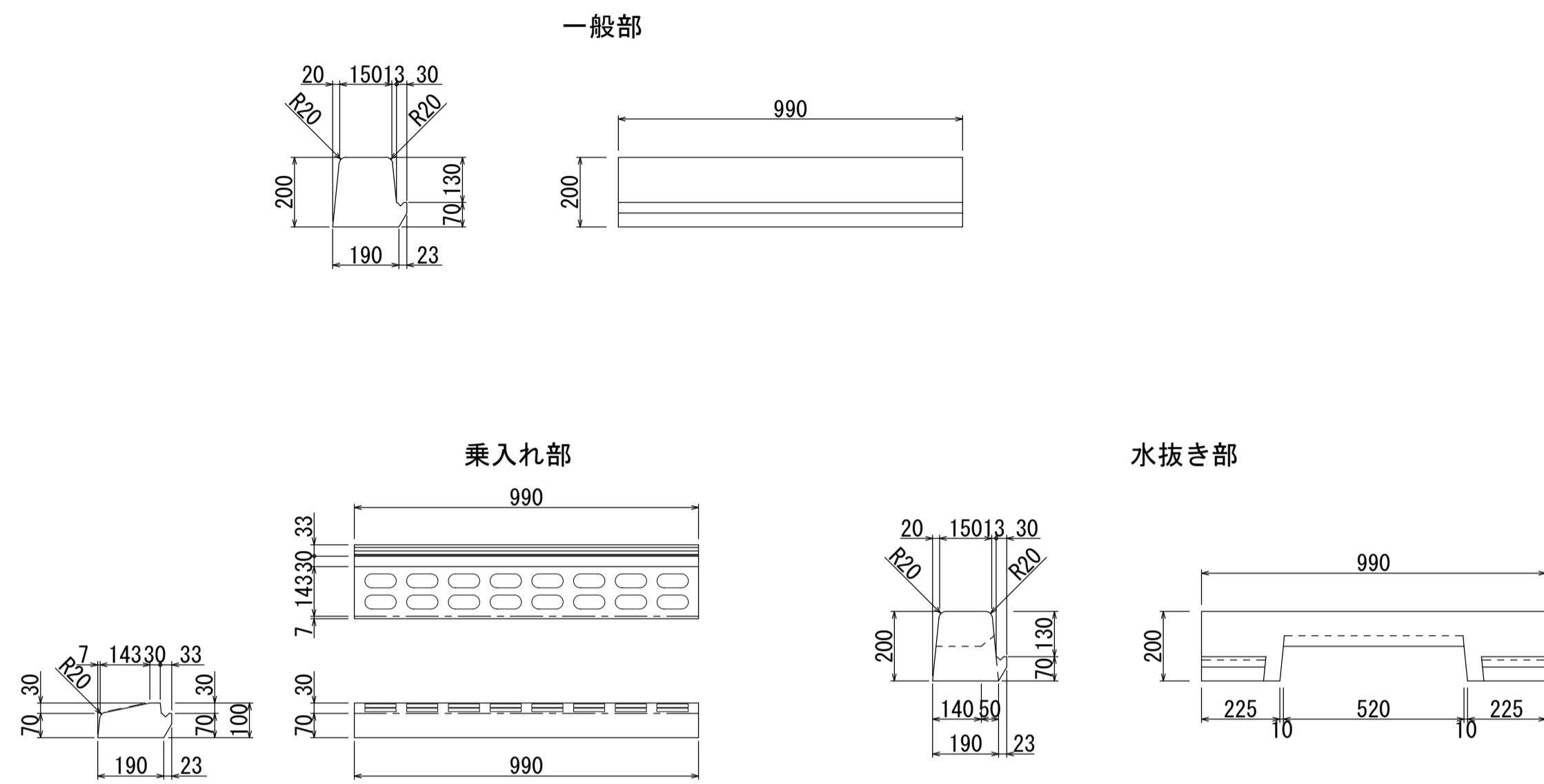
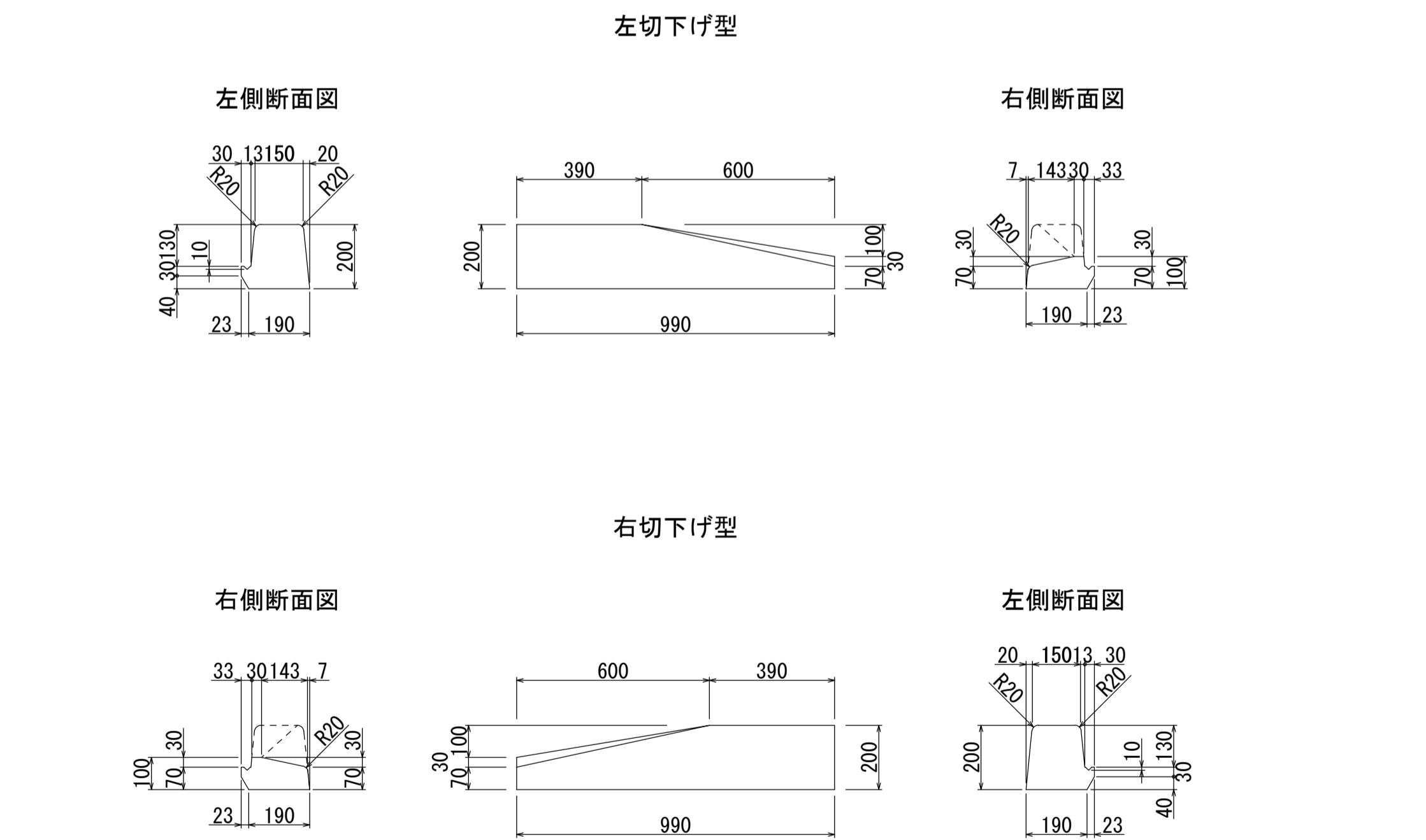
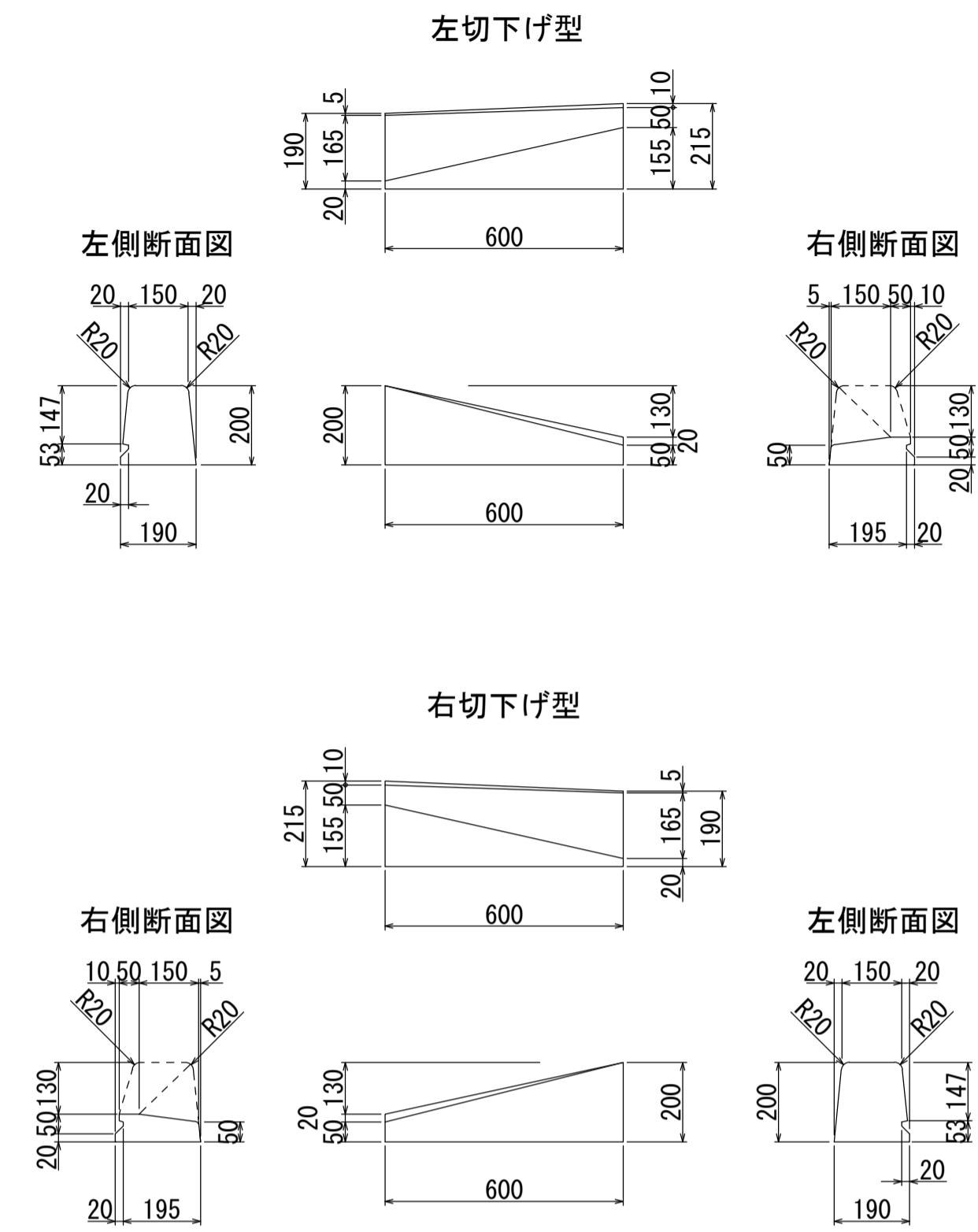

滑り止めゴム凸溝寸法

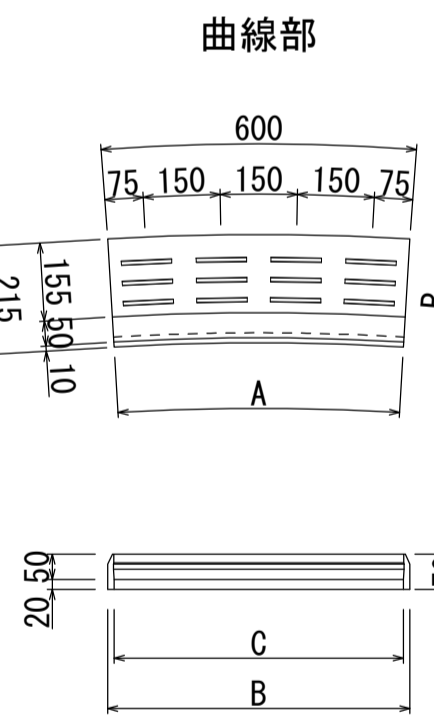
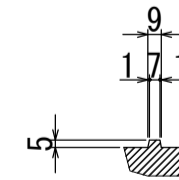

R別寸法一覧表

R (m)	A (mm)	B (mm)	C (mm)
2.0	536	598	534
3.0	557	599	556
4.0	568	599	567
5.0	574	600	574
6.0	579	600	578
7.0	582	600	581

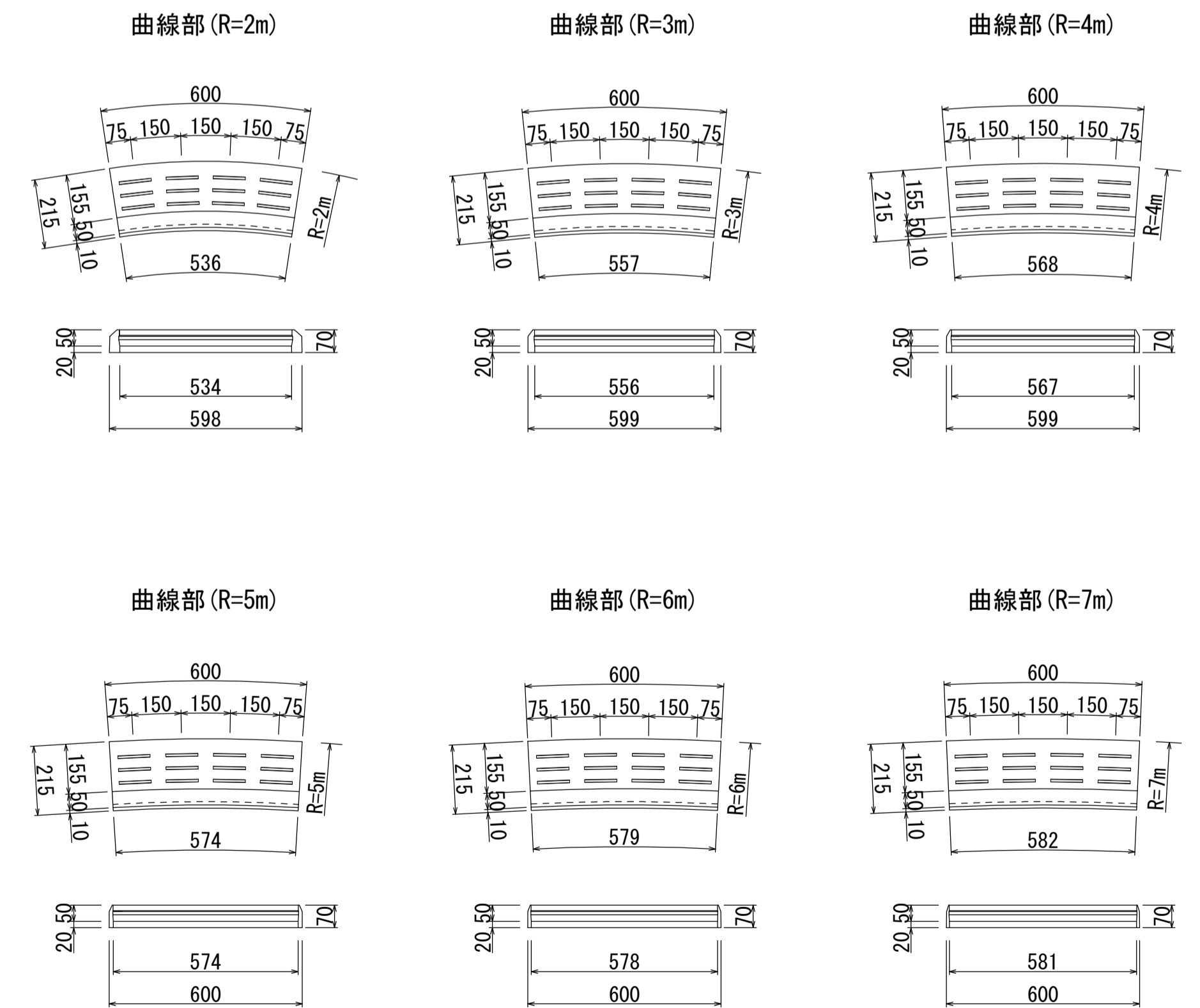

名称	歩車道境界ブロック (群馬県型管渠型側溝用)		
縮尺	1:15	日付	2023.7.1
会社名	藤岡コンクリート工業株式会社		